

**Installation Instructions**

900352-01 – PIM Cable Support Bar, Pole Mount Kit, 13 Position

900352-02 – PIM Cable Support Bar, Pole Mount Kit, 13 Position, Extended Range

**STEP 1**

Attach threaded rods to bracket, set to correct offset length. (Torque greater than 20 Ft-lb)

**STEP 2**

Attach saddle brackets to pole.

**STEP 3**

Attach 13 Position Bar to threaded rods.

Torque: 20 Ft-lb all connections  
(ConcealFab Tool PN: 900413)

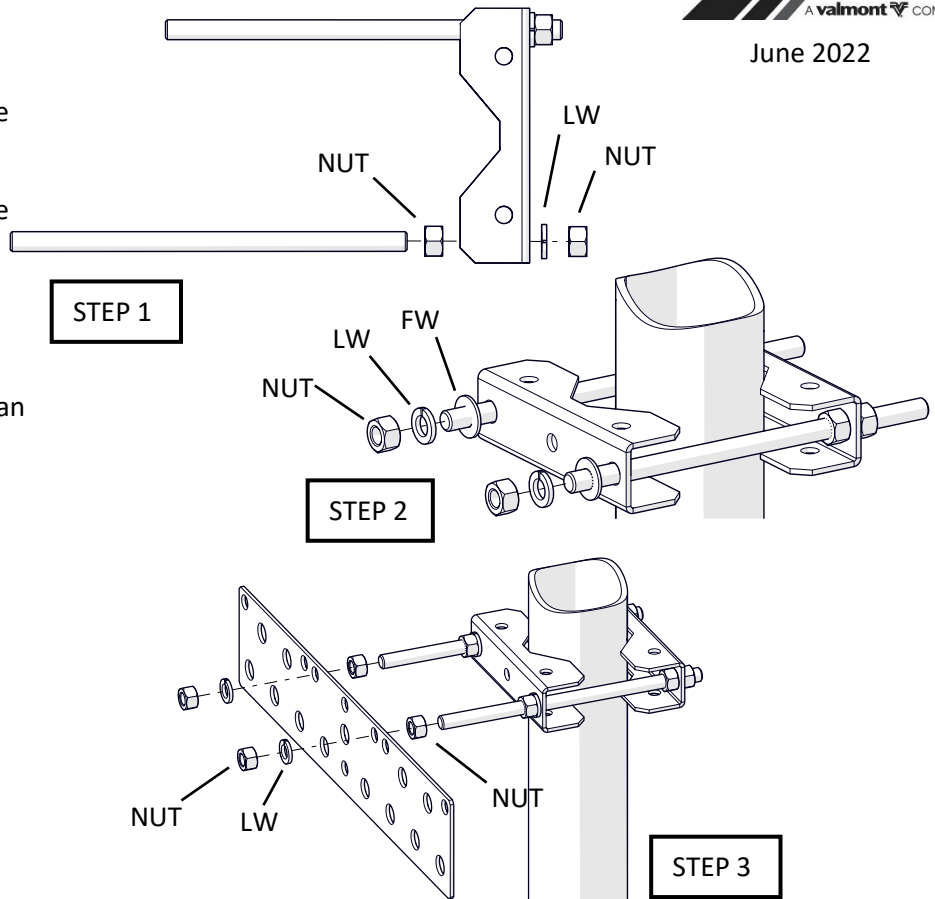

**Installation Instructions**

900352-01 – PIM Cable Support Bar, Pole Mount Kit, 13 Position

900352-02 – PIM Cable Support Bar, Pole Mount Kit, 13 Position, Extended Range

**STEP 1**

Attach threaded rods to bracket, set to correct offset length. (Torque greater than 20 Ft-lb)

**STEP 2**

Attach saddle brackets to pole.

**STEP 3**

Attach 13 Position Bar to threaded rods.

Torque: 20 Ft-lb all connections  
(ConcealFab Tool PN: 900413)

